



Available online at [www.academicpaper.org](http://www.academicpaper.org)

**Academic @ Paper**

International Journal of Energy  
Applications and Technologies

Vol. 3, Issue 2, pp. 60 – 67, 2016



[www.academicpaper.org/index.php/IJEAT](http://www.academicpaper.org/index.php/IJEAT)

**Research Article**

## **ENERGY ANALYSIS FOR AN AIR-CONDITIONING SYSTEM OF A COMMERCIAL AIRCRAFT: CASE STUDY FOR AIRBUS A330**

Yasin Ozdemir<sup>1</sup>, Muammer Ozgoren<sup>2</sup>, Ilker Goktepel<sup>2\*</sup>

<sup>1</sup> Third Main Jet Base, Konya, Turkey

<sup>2</sup> Department of Mechanical Engineering, Faculty of Engineering, Selcuk University, Konya, Turkey

Received 5<sup>th</sup> November 2016, Accepted 6<sup>th</sup> November 2016

### **Abstract**

The regulation of temperature, pressure, humidity and oxygen intensity of an aircraft cabin is crucial for the flight conditions of a commercial aircraft. Lack of oxygen, lower temperature and pressure induce some health problems for passengers on board. For this reason, hot and pressurized air supplied from aircraft engine compressor section is conditioned in the air-conditioning packages to present comfortable ambience inside of the aircraft cabin as well as cooling of electric components. In this study, an air-conditioning system of Airbus A330 as a commercial aircraft has been investigated at the altitude of 11000 m for 289 people on board under the flight conditions. At this altitude for the aircraft cruising with 871 km/h ( $Ma = 0.82$ ), cooling loads of cockpit (crew station), passenger cabin and other appliances needed cooling in the aircraft have been calculated. The parameters affecting the cooling load are mainly temperature, pressure and air intensity of aircraft inside and atmospheric outside. In the calculation of the cooling loads, generated heat and heat loss have been considered. For the generated heat value, heat generation by passengers, cabin crew, illumination systems, other equipment and solar radiation have been assumedly calculated. The heat loss from the aircraft fuselage at 20 °C cabin to the outside of the aircraft at -56.5 °C has been found. Heat transfer to meet the fresh air need inside the aircraft has been taken into account. Finally, the obtained cooling loads are 7.4 kW for the maximum value and 5.1 kW for the minimum value at these aforementioned conditions. The maximum and minimum values have been obtained for the daytime and the night time depending on solar radiation, respectively. In the upcoming study, energy analysis is going to be combined with the exergy analysis and the appropriate air-conditioning system for the optimum energy consumption will be evaluated.

**Keywords-** *Air-conditioning, aircraft, altitude, cooling load, energy analysis.*

### **1. Introduction**

Aircraft cabin temperature and pressure are very important to be conditioned as the passenger aircrafts cruise at high altitudes and at also various conditions. Due to lower pressure and temperature at higher altitudes, air-conditioning system of aircrafts play an important role for both human health and comfort conditions. For this reason, pressurized and hot air of aircraft engine is evaluated to provide high class air

ambient inside of the aircraft cabin. Another case is pressurization of the aircraft cabin and it is very crucial to maintain the optimum pressure level at lower altitudes as the cabin has to be impermeable under any circumstances. With this way, high oxygen density can be supplied to the aircraft cabin through the pressurized air as this a significant step to ensure the air-conditioning for passenger health. In present study, an air-conditioning system of Airbus A330-300 RR Trent 700 as a commercial aircraft has been considered for 289 people on board. It is assumed to be cruised at the altitude of 11000 m (correspondingly 36100 ft) with the speed of 871 km/h. Various studies in the literature could be encountered about the air-conditioning of an aircraft cabin. Hocking (2002) has studied on trends in cabin air quality of commercial aircraft in terms of industry and passenger

\* Corresponding Authors;

[ilkerkogtepel@selcuk.edu.tr](mailto:ilkerkogtepel@selcuk.edu.tr)

[yozdemir9@hvk.tsk.mil.tr](mailto:yozdemir9@hvk.tsk.mil.tr)

Note: This paper has been presented at the International Conference on Advanced Technology & Sciences (ICAT'16) held in Konya (Turkey).

perspectives. It has been presented that improving the aircraft cabin air quality and the partial pressure of oxygen can be provided for minimal cost [1]. Cakir et al. (2003) have presented a study about air-conditioning system in commercial aircrafts and comfort. They have explained the importance of air-conditioning system as it is not easy to provide comfortable and fast trips at high altitudes [2]. Arslan et al. (2009) have investigated the air-conditioning system of an aircraft and its effect to inner air quality. In their study, Boeing 737-800 has been used and they have stated that the filters, sensors, indicators and the control and maintenance of the equipment are substantial for the air-conditioning system of the aircraft [3]. Dumas et al. (2014) have defined a design methodology for the global thermodynamic performance of an airship cabin for high altitude. A fundamental cabin sizing and energetic performance of cabin thermal insulation have been provided [4]. Chen et al. (2015) have studied on hot air distribution of ship cabin air-conditioning. They have pointed out that the ship cabin air-conditioning formed suitable air distribution for characteristics of variable air volume, big air volume and high air velocity [5]. Oliveira et al. (2015) have evaluated the passive aircraft cooling systems for variable thermal conditions. The fuselage condenser performance has been tested for the temperature range between  $-30\text{ }^{\circ}\text{C}$  and  $50\text{ }^{\circ}\text{C}$ . They have determined that heat removal capacity of the fuselage was more dominant in terms of forced convection acting on all condensers [6]. Yang et al. (2015) have researched on the numerical simulation of aircraft cabin smoke as it is a threat for the flight safety severely. They have analyzed the flow regularity of smoke in the aircraft cabin and also the influence of ventilation on cabin smoke diffusion. It is certain that high level of ventilation could decrease the smoke and temperature distributions, effectively [7]. Yao et al. (2015) have examined the flow characteristics and turbulence simulation for an aircraft cabin environment. They have utilized BV2fAM simulation and have theoretically showed that topological structure of flow fields in the cabin was unstable [8]. Zhu et al. (2015) have considered the air distribution with natural convection effect of passengers in an air cabin mockup by using PIV experimental setup. They have observed the interaction between natural convection from the passengers and forced convection from the supply air diffusers. They have measured the air flow jet in a 7-row cabin mockup and have concluded that air jet decay rate was slower with increment of natural convection [9]. Čavka et al. (2016) have dealt with energy efficiency in aircraft cabin environment in the context of safety and design. They have emphasized that cabin air temperature, cabin noise, cabin evacuation time and accident rate were the certain parameters for the consideration of aforementioned issues [10]. The aim of this study is energy analysis for an air-conditioning system of a commercial aircraft in case of Airbus A330.

## 2. Composition of Atmosphere

The mixture of gases that make up the atmosphere of the earth is commonly called air. It is composed principally of 78% nitrogen and 21% oxygen and the remaining 1% is made up of various gases in smaller quantities as shown in Fig. 1. Some of these are important to human life, such as carbon dioxide, water vapor, and ozone. Fig. 1. indicates the respective percentage of the quantity of each gas in its relation to the total mixture [11].

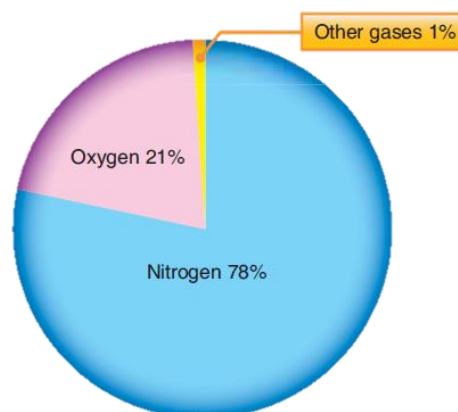

Fig. 1. The percentage of the various gases that comprise the atmosphere [11].

As altitude increases, the total quantity of all the atmospheric gases reduces rapidly. However, the relative proportions of nitrogen and oxygen remain unchanged up to about 50 miles above the surface of the earth. The percentage of carbon dioxide is also fairly stable. The amounts of water vapor and ozone vary [11].

Nitrogen is an inert gas that is not used directly by man for life processes; however, many compounds containing nitrogen are essential to all living matter [11].

The small quantity of carbon dioxide in the atmosphere is utilized by plants during photosynthesis. Thus, the food supply for all animals, including man, depends on it. Carbon dioxide also helps control breathing in man and other animals [11]. The amount of water vapor in the atmosphere is variable but, even under humid conditions at sea level, it rarely exceeds 5%. Water also occurs in the atmosphere as ice crystals. All forms of water in the atmosphere absorb far more energy from the sun than do the other gases. Water plays an important role in the formation of weather [11].

Ozone is a form of oxygen. It contains three oxygen atoms per molecule, rather than the usual two. Most of the ozone of atmosphere is formed by the interaction of oxygen and the rays of sun near the top of the stratosphere in an area called the ozone layer. This is important to living organisms because ozone filters out most of the sun's harmful ultraviolet (UV) radiation. Ozone is also produced by electrical discharges, such as lightning strikes. It has a faint odor, somewhat like that of weak chlorine, that may be detected after a thunderstorm. Auroras and cosmic

rays may also produce ozone. Ozone is of great consequence to living creatures on earth and to the circulation of the upper atmosphere [11].

### 3. Flight Conditions

Aircrafts are able to cruise at various flight and climate conditions, successfully. At these conditions, the regulation of temperature, pressure, humidity and oxygen intensity of an aircraft cabin is crucial for a commercial aircraft as many passengers are on board. These parameters tend to change with respect to the cruise altitude as in Table 1. It indicates that there is a decrease in temperature while rise in altitudes is observed. Particularly, this decrease is seen for the pressure for increasing altitudes. As mentioned before, the total quantity of all the atmospheric gases goes down swiftly because of increase in altitude values.

**Table 1.** International atmosphere standards [2].

| Altitude |        | Temperature | Pressure |
|----------|--------|-------------|----------|
| Feet     | Meters | °C          | milibars |
| 1000     | 304.8  | 13.17       | 977.1    |
| 10000    | 3048   | -4.66       | 696.8    |
| 20000    | 6096   | -24.57      | 465.6    |
| 30000    | 9144   | -44.29      | 300.9    |
| 36100    | 11000  | -56.5       | 226.2    |

Heat sources for a passenger are solar radiation, the heat of air supplied by air-conditioning system and the heat released by other passengers. Moreover, inner air temperature is conditioned with the help of air-conditioning system in the aircraft cabin. Inner air temperature is adjustable in range of 18.5 °C and 29.5 °C with respect to the human health and comfort conditions [2]. However, cabin temperature is under effect of static and dynamic situations. Another heat source except the air-conditioning system is due to the passengers. At rest, a person generates heat between 80 - 100 W in terms of static situation [2]. On the other hand, dynamic situation includes the motion of passengers on board or power-up, take-off and landing of the aircraft. When relative humidity value is investigated, the maximum altitude for the flight of an aircraft presents nearly same humidity value with the driest region of the world. It is obvious that these conditions can cause illnesses and diseases in terms of human health. Therefore, air-conditioning system of an aircraft cabin is significant for previously stated situations. In addition, less oxygen level is seen at higher altitudes. Especially, lack of oxygen for human health is observed and felt after the altitude of 3000 m [2]. This situation affects negatively the respiratory system of a person. For this reason, it is needed to serve ambient quality equivalent to the sea level conditions and it is named as cabin altitude. In air-conditioning system for aviation applications, there are two alternatives to reduce the cabin altitude. Firstly, it can be done by providing sufficient oxygen level or second way is to increase the air pressure. In aviation, global cabin altitude for a commercial aircraft is 8000 ft (2438 m) and it is limit value for a

person to breathe on his/her own without any appliances [2].

### 4. Air-Conditioning System

There are two types of air conditioning systems commonly used on aircraft. Air cycle air conditioning is used on most turbine-powered aircraft. It makes use of engine bleed air or APU pneumatic air during the conditioning process. Vapor cycle air conditioning systems are often used on reciprocating aircraft. This type system is similar to that found in homes and automobiles. It is known that some turbine-powered aircraft also use vapor cycle air conditioning [11]. Air-conditioning system of a commercial aircraft aims following cases such as heating, cooling, equipment cooling, mission cooling, pressurization, distribution and temperature control as indicated in Fig. 2.

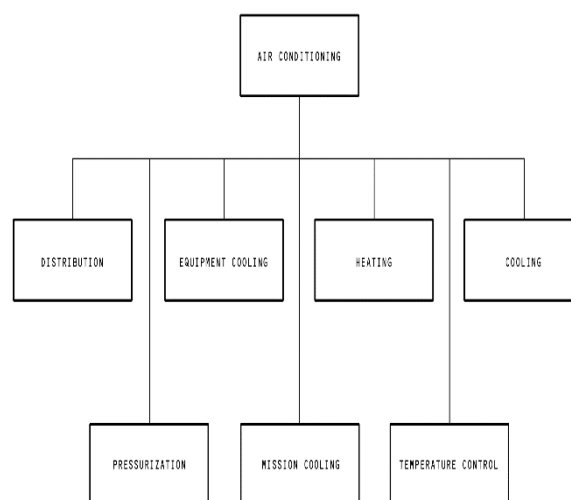

**Fig. 2.** General description of air-conditioning system [12].

Thanks to air-conditioning system in the aircraft cabin, stable comfort conditions are performed for pilots, cabin crew and passenger even the aircraft cruising at different flight scenarios. At normal conditions, air requirement is supplied from the compressor stages of the engine by aircraft pneumatic system, Auxiliary Power Unit (APU) or another source if it does not fly. Hot air obtained from the engine is directed to air-conditioning package units through air ducts. After that, air is cooled in these units and canalized to cold air manifold. In the meantime, hot air withdrawn from the engine is sent to hot air manifold to be kept there for the next step. The mixture of hot and cold air is despatched to the aircraft cabin.

As in Fig. 3, the hot compressed air is cooled, conditioned and delivered to the fuselage compartments and then discharged overboard through two outflow valves. Fresh air can also be supplied to the distribution system through two low-pressure ground connections. A ram air inlet supplies emergency air to fuselage if there is a complete failure of the air generation system during flight. A mixing manifold mixes fresh air with cabin air. The cabin air that enters the underfloor area is drawn through

recirculation filters by fans. The recirculation fans then blow the air through check valves to the mixing manifold. The flight deck is supplied by fresh air only [13].

Hot bleed air is tapped downstream of the pack valves. The air flows through two hot air valves which control the pressure of the hot trim air going into two hot air manifolds. To control the temperature in the different upper deck zones, the quantity of trim air added is controlled through the cockpit and cabin temperature control system [13]. By the way, component locations of an air-conditioning system in the aircraft have been shown in Fig. 4.

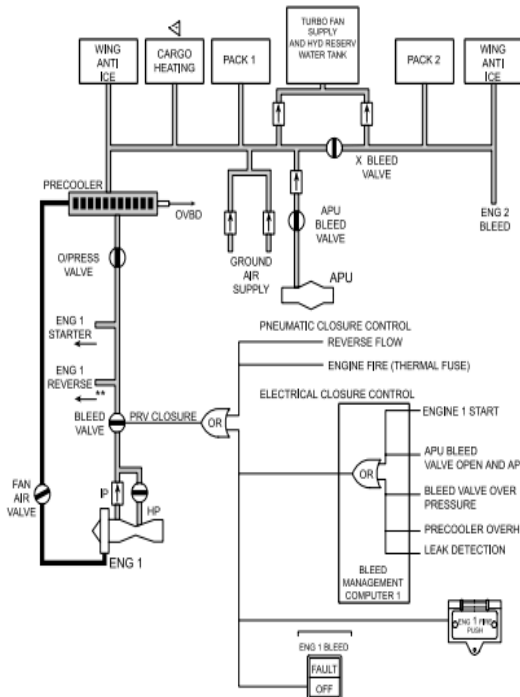

Fig. 3. Airbus A330 Environmental Control System [13].

Hot air is delivered to air supply ducts through the related zone trim air valves. The trim air valves are controlled through the temperature requirements of each zone and duplicated for cabin zone flexibility. The trim air system has several features to ensure that no substantial comfort degradation occurs in case of trim air valve or hot air valve failure; a hot cross-bleed valve is installed between the hot air manifolds and will open to maintain trim air supply to all rise ducts in the event of hot air failure (blocked closed). Moreover, in the event of trim air failure (blocked open) and/or duct overheat, as the shut-off valve is normally closed and there are two riser ducts per cabin zone, only half of each zone will lose its trim air supply. The flight deck is permanently supplied by a constant restricted trim air flow in addition to the normal controlled trim air supply [13].

Heat is an expression of energy, typically measured by temperature. The higher the temperature of a substance, the more energy it contains. Heat always flows from hot to cold. These terms express the relative amount of energy present in two substances. They do not measure the absolute amount of heat

present. Without a difference in energy levels, there is no transfer of heat energy [11].

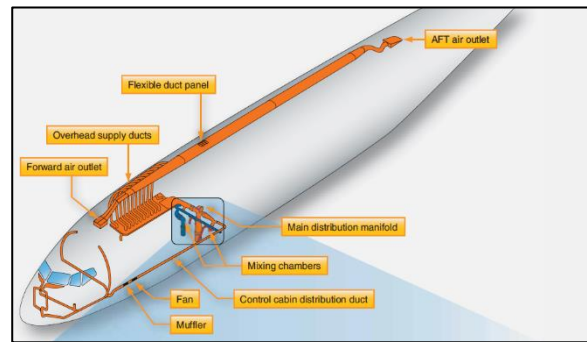

Fig. 4. Component locations of an air-conditioning system in the aircraft [11].

Adding heat to a substance does not always raise its temperature. When a substance changes state, such as when liquid changes into a vapor, heat energy is absorbed. This is called latent heat. When a vapor condenses into a liquid, this heat energy is given off. The temperature of a substance remains constant during its change of state. All energy absorbed or given off, the latent heat is used for the change process. Once the change of state is complete, heat added to a substance raises the temperature of the substance. After a substance changes state into a vapor, the rise in temperature of the vapor caused by the addition of still more heat is called superheat [11]. The temperature at which a substance changes from a liquid into a vapor when heat is added is known as its boiling point. This is the same temperature at which a vapor condenses into a liquid when heat is removed. The boiling point of any substance varies directly with pressure. When pressure on a liquid is increased, its boiling point increases, and when pressure on a liquid is decreased, its boiling point also decreases. Vapor pressure is the pressure of the vapor that exists above a liquid that is in an enclosed container at any given temperature. The vapor pressure developed by various substances is unique to each substance [11].

### Air cycle air-conditioning

Air cycle air-conditioning prepares engine bleed air to pressurize the aircraft cabin as seen in Fig 5. The temperature and quantity of the air must be controlled to maintain a comfortable cabin environment at all altitudes and on the ground. The air cycle system is often called the air conditioning package or pack. It is usually located in the lower half of the fuselage or in the tail section of turbine-powered aircraft [11]. Even with the frigid temperatures experienced at high altitudes, bleed air is too hot to be used in the cabin without being cooled. It is let into the air cycle system and routed through a heat exchanger where ram air cools the bleed air. This cooled bleed air is directed into an air cycle machine. There, it is compressed before flowing through a secondary heat exchange that cools the air again with ram air. The bleed air then flows back into the air cycle machine where it drives an expansion turbine and cools even further. Water is



then removed and the air is mixed with bypassed bleed air for final temperature adjustment. It is sent to the cabin through the air distribution system. By examining the operation of each component in the air cycle process, a better understanding can be developed of how bleed air is conditioned for cabin use [11].

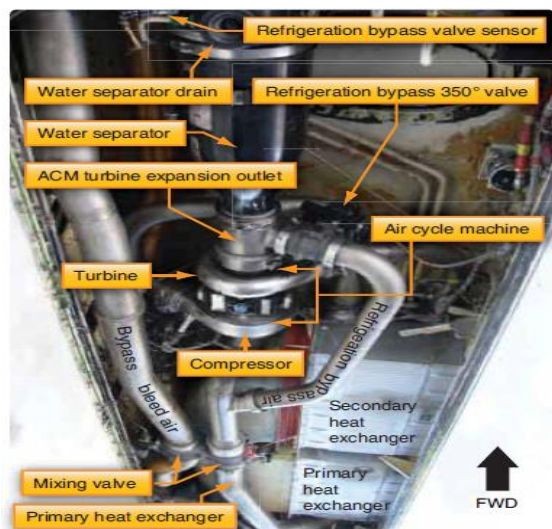

Fig. 5. Air cycle air-conditioning [11].

Most cabin temperature control systems operate in a similar manner. Temperature is monitored in the cabin, cockpit, conditioned air ducts, and distribution air ducts. These values are input into a temperature controller, or temperature control regulator, normally located in the electronics bay. A temperature selector in the cockpit can be adjusted to input the desired temperature. The temperature controller compares the actual temperature signals received from the various sensors with the desired temperature input. Circuit logic for the selected mode processes these input signals. An output signal is sent to a valve in the air cycle air conditioning system. This valve has different names depending on the aircraft manufacturer and design of the environmental control systems (i.e., mixing valve, temperature control valve and trim air valve). It mixes warm bleed air that bypassed the air cycle cooling process with the cold air produced. By modulating the valve in response to the signal from the temperature controller, air of the selected temperature is sent to the cabin through the air distribution system. [11].

Cabin temperature pickup units and duct temperature sensors used in the temperature control system are thermistors. Their resistance changes as temperature changes. The temperature selector is a rheostat that varies its resistance as the knob is turned. In the temperature controller, resistances are compared in a bridge circuit. The bridge output feeds a temperature regulating function. An electric signal output is prepared and sent to the valve that mixes hot and cold air. On large aircraft with separate temperature zones, trim air modulating valves for each zone are used. The valves modulate to provide the correct mix required to match the selected temperature. Cabin, flight deck,

and duct temperature sensors are strategically located to provide useful information to control cabin temperature [11].

### Vapor cycle air-conditioning

The absence of a bleed air source on reciprocating engine aircraft makes the use of an air cycle system impractical for conditioning cabin air.

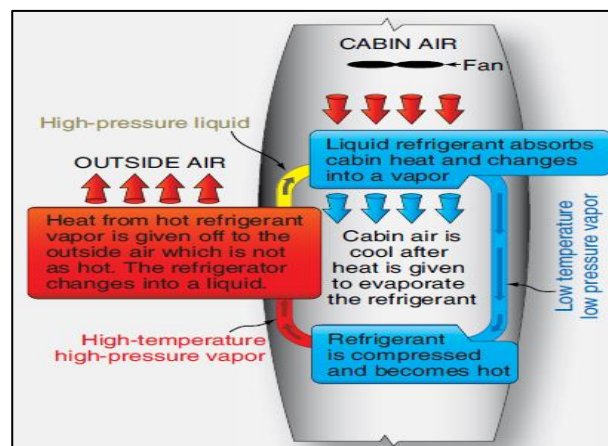

Fig. 6. Vapor cycle air-conditioning [11].

Vapor cycle air conditioning is used on most non-turbine aircraft that are equipped with air conditioning. However, it is not a source of pressurizing air as the air cycle system conditioned air is on turbine powered aircraft. The vapor cycle system only cools the cabin. If an aircraft equipped with a vapor cycle air conditioning system is pressurized, it uses one of the sources discussed in the pressurization section above. Vapor cycle air conditioning is a closed system used solely for the transfer of heat from inside the cabin to outside of the cabin. It can operate on the ground and in flight. This cycle has been shown in Fig. 6 [11].

In the theory of refrigeration, energy can be neither created nor destroyed; however, it can be transformed and moved. This is what occurs during vapor cycle air conditioning. Heat energy is moved from the cabin air into a liquid refrigerant. Due to the additional energy, the liquid changes into a vapor. The vapor is compressed and becomes very hot. It is removed from the cabin where the very hot vapor refrigerant transfers its heat energy to the outside air. In doing so, the refrigerant cools and condenses back into a liquid. The refrigerant returns to the cabin to repeat the cycle of energy transfer [11].

### 5. Approximate Energy Analysis

In this study, energy analysis for an air-conditioning system of Airbus A330-300 RR Trent 700 as a commercial aircraft has been performed for 289 people on board. It has been indicated in Fig. 7. Even though the maximum speed of the aircraft is 913 km/h, it is assumed to be cruised at the altitude of 11000 m (correspondingly 36100 ft) with the speed of 871 km/h. In the calculation of the cooling loads, generated heat and heat loss have been considered. For

the generated heat value, heat generation by passengers, cabin crew, illumination systems, other equipment and solar radiation have been assumedly calculated. The heat loss from the aircraft fuselage at  $T_{cabin} = 20\text{ }^{\circ}\text{C}$  (293.15 K) cabin to the outside of the aircraft at  $T_{surface} = -56.5\text{ }^{\circ}\text{C}$  (216.65 K) has been found.



Fig. 7. Airbus A330-300 RR Trent 700 [13].

Mach number (Ma) for the flight conditions has been calculated with respect to Eq. (1):

$$Ma = \frac{V}{c} \quad (1)$$

Here, “V” symbolizes the aircraft speed and “c” stands for the speed of sound. For the aircraft, the cruise speed is  $V = 871\text{ km/h}$  (correspondingly  $V = 241.94\text{ m/s}$ ). The speed of sound (c) is calculated by Eq. (2):

$$c = \sqrt{kRT} \quad (2)$$

In the equation, “k” is the heat capacity ratio and equals to  $k_{air} = 1.4$  for air. “R” is the specific gas constant and its value for air is  $R_{air} = 287\text{ J/kgK}$ . In the formula, T is  $T_{surface} = 216.65\text{ K}$  for the outside of the aircraft. According to Eq. (2), the speed of sound has been found to be  $c = 295.04\text{ m/s}$ . After obtaining the speed of sound, Mach number in this condition has been determined as  $Ma = 0.82$  by Eq. (1). It is subsonic flow as  $Ma = 0.82 < 1$ .

Table 2. Materials used in the fuselage of the aircraft.

| Material (With thickness)                    | Thermal conductivity             |
|--|----------------------------------|
| Inner coatings ( $L_1 = 0.002\text{ m}$ )    | $\lambda_1 = 1.4\text{ W/mK}$    |
| Honeycomb ( $L_2 = 0.015\text{ m}$ )         | $\lambda_2 = 0.02\text{ W/mK}$   |
| Insulation material ( $L_3 = 0.1\text{ m}$ ) | $\lambda_3 = 0.04\text{ W/mK}$   |
| Outer shell ( $L_4 = 0.0015\text{ m}$ )      | $\lambda_4 = 120.08\text{ W/mK}$ |

In the fuselage of the aircraft, used materials have been indicated with the thickness value (L) in Table II. Moreover, thermal conductivity values ( $\lambda$ ) for these materials have been presented. Inner heat transfer coefficient has been assumed to be  $\alpha_{inner} = 12\text{ W/m}^2\text{K}$  and outer heat transfer coefficient has been considered as  $\alpha_{outer} = 300\text{ W/m}^2\text{K}$  for the flight conditions.

$$\frac{1}{U} = \frac{1}{\alpha_{inner}} + \frac{L_1}{\lambda_1} + \frac{L_2}{\lambda_2} + \frac{L_3}{\lambda_3} + \frac{L_4}{\lambda_4} + \frac{1}{\alpha_{outer}} \quad (3)$$

Overall heat transfer coefficient (U) has been calculated by Eq. (3) and it has been found to be  $U = 0.3\text{ W/m}^2\text{K}$ .

$$A = \pi D L \quad (4)$$

Here, and the diameter of the fuselage is  $D = 5.67\text{ m}$  as in Fig. 8 while the length of the fuselage is  $L = 63.69\text{ m}$ .

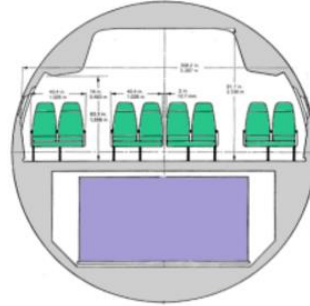

Fig. 8. Cross-sectional area of Airbus A330-300 RR Trent 700 [13].

Heat transfer area for Airbus A330-300 RR Trent 700 has been obtained with respect to Eq. (4) and it has been found to be  $A = 1128.5\text{ m}^2$ .

$$\Delta T = T_{cabin} - T_{surface} \quad (5)$$

In Eq. (5), the temperature of the cabin is  $T_{cabin} = 20\text{ }^{\circ}\text{C}$  (293.15 K) and the outside temperature of the aircraft is  $T_{surface} = -56.5\text{ }^{\circ}\text{C}$  (216.65 K). Temperature difference ( $\Delta T$ ) has been considered by Eq. (5) and it is  $\Delta T = 76.5\text{ }^{\circ}\text{C}$  (76.5 K).

$$\dot{Q}_{loss} = U A \Delta T \quad (6)$$

In this situation, heat loss has been calculated by Eq. (6) and it has been found to be  $\dot{Q}_{loss} \cong 25.9\text{ kW}$  for the aforementioned case. After the heat loss has been evaluated, the next step is to calculate the heat generated in the aircraft. As it was mentioned before, a person generates heat between 80 – 100 W in terms of static situation. It has been assumed to be average 80 W of the heat generated per capita. Heat generated by people on board has been calculated with respect to Eq. (7):

$$\dot{Q}_{people} = (\text{Number of people}) (\text{Heat gen. per capita}) \quad (7)$$

Here, the number of people on board is 289 and average heat generation per capita is 80 W. The result has been obtained as  $\dot{Q}_{people} \cong 23.12\text{ kW}$ . Heat generation by the devices of the aircraft has been taken as  $\dot{Q}_{devices} \cong 2\text{ kW}$ .

For the lighting, there are 50 fluorescent lamps with 12 W for each and 150 fluorescent lamps with 35 W. Heat generation due to the lighting:

$$\dot{Q}_{lighting} = \Sigma[(\text{Number of lamps}) (\text{Power of each one})] \quad (8)$$

It has been obtained as  $\dot{Q}_{\text{lighting}} \cong 5.85$  kW by using Eq. (8) for the calculation.

In case the glass transmissivity is 40%, solar radiation acting on the glass area of  $A_{\text{total}} = 8.31$  m<sup>2</sup> has been calculated by Eq. (9) and total solar irradiance (TSI) has been taken into account as 700 W/m<sup>2</sup>.

$$\dot{Q}_{\text{radiation}} = (\text{Area}) (\text{Total solar radiance}) \quad (9)$$

Here,  $\dot{Q}_{\text{radiation}}$  has been obtained for the glass transmissivity value of 100% and then calculated for %40 transmissivity as  $\dot{Q}_{\text{radiation}} \cong 2.33$  kW for these conditions.

Total heat generation has been found by using Eq. (10):

$$\dot{Q}_{\text{generated}} = \dot{Q}_{\text{people}} + \dot{Q}_{\text{devices}} + \dot{Q}_{\text{lighting}} + \dot{Q}_{\text{radiation}} \quad (10)$$

With respect to Eq. (10),  $\dot{Q}_{\text{generated}} \cong 33.3$  kW has been obtained for the daytime as it includes  $\dot{Q}_{\text{radiation}} \cong 2.33$  kW. On the other hand,  $\dot{Q}_{\text{generated}} \cong 31$  kW has been calculated for the night time excluding  $\dot{Q}_{\text{radiation}}$  in the calculation.

After calculating the heat generation values for both the daytime and the night time separately, cooling loads provided by the air-conditioning system have been attained by using Eq. (11):

$$\dot{Q}_{\text{cooling}} + \dot{Q}_{\text{generated}} = \dot{Q}_{\text{loss}} \quad (11)$$

Here,  $\dot{Q}_{\text{cooling}} \cong -7.4$  kW as a maximum value has been evaluated for the daytime including the solar radiation. Besides,  $\dot{Q}_{\text{cooling}} \cong -5.1$  kW as a minimum value has been calculated for the night time excluding the solar radiation. The negative sign in front of the cooling load shows that air-conditioning system works in the aircraft.

## 6. Conclusion

The adjustment of temperature, pressure, humidity and oxygen intensity of the aircraft cabin is important when the flight conditions of a commercial aircraft are taken into account. Health problems especially for passengers on board could be seen due to adverse conditions. That is why; hot and pressurized air obtained from aircraft engine compressor zones is conditioned in the air-conditioning system to present comfortable ambience inside of the aircraft cabin. In present study, an air-conditioning system of Airbus A330 has been examined at the cruise altitude of 11000 m for 289 people on board. At this altitude for the aircraft cruising with 871 km/h (Ma = 0.82), cooling loads of cockpit (crew station), passenger cabin and other appliances required cooling in the aircraft have been obtained. The effective parameters on cooling load have been determined as temperature, pressure and air density of aircraft inside and atmospheric outside. In the calculation of the cooling

loads, generated heat and heat loss have been considered. For the generated heat value, heat generation by passengers, cabin crew, illumination systems, other equipment and solar radiation have been assumedly calculated. The heat loss from the aircraft fuselage at 20 °C cabin to the outside of the aircraft at -56.5 °C has been found. To sum up, obtained cooling loads are 7.4 kW for the maximum value and 5.1 kW for the minimum value at these aforementioned conditions in terms of the daytime and night time depending on solar radiation, respectively. These maximum and minimum values have been attained with the negative sign in front of their values and it indicates that air conditioning system of this aircraft operates successfully under considered conditions.

## Acknowledgment

The authors would like to acknowledge the funding of Academic Staff Training Program (OYP) for project no. of 2015-OYP-007 and the financial support from Scientific Research Project Office of Selcuk University.

## References

- [1] M. B. Hocking, "Trends in cabin air quality of commercial aircraft: industry and passenger perspectives", *Reviews on Environmental Health*, vol. 17, pp. 1-50, Jan. 2002.
- [2] K. Cakir, M. Ocal and I. Taymaz, "An air-conditioning system in the commercial aircrafts and comfort", *Sakarya University Journal of Science*, vol. 7, pp. 229-235, July 2003.
- [3] B. Arslan, T. H. Karakoc, Y. Yoru and O. Altuntas, "Aircraft systems and indoor air quality on climate effects", *Engineer and Machine*, vol. 51, pp. 9-19, Aug. 2010.
- [4] A. Dumas, D. Angeli and M. Trancossi, "High altitude airship cabin sizing, pressurization and air conditioning", *Energy Procedia*, vol. 45, pp. 977-986, 2014.
- [5] J. Chen, W. Wang, M. L. Qu and W. Yin, "Study on hot air distribution of ship cabin air-conditioning", *Procedia Engineering*, vol. 121, pp. 1420-1427, 2015.
- [6] J. L. G. Oliveira, C. Tecchio, K. V. Paiva, M. B. H. Mantelli, R. Gandolfi and L. G. S. Ribeiro, "Passive aircraft cooling systems for variable thermal conditions", *Applied Thermal Engineering*, vol. 79, pp. 88-97, Mar. 2015.
- [7] S. Yang, X. Sun, T. Yu and X. Chen, "Research on the numerical simulation of aircraft cabin smoke", *Procedia Engineering*, vol. 121, pp. 357-364, 2015.
- [8] Z. Yao, X. Zhang, C. Yang and F. He, "Flow characteristics and turbulence simulation for an aircraft cabin environment", *Procedia Engineering*, vol. 121, pp. 1266-1273, 2015.
- [9] X. Zhu, J. Liu, X. Cao and J. Li, "2D-PIV experimental study on the air distribution with

- natural convection effect of passengers in an air cabin mockup”, *Procedia Engineering*, vol. 121, pp. 866-874, 2015.
- [10] I. Čavka, O. Čokorilo and L. Vasov, “Energy efficiency in aircraft cabin environment: Safety and design”, *Energy and Buildings*, vol. 115, pp. 63-68, Mar. 2016.
- [11] Anonymous, “Cabin Environmental Control Systems”, *U.S. Department of Transportation - Federal Aviation Administration*, 2012.
- [12] Anonymous, “Boeing P600 Mod 3 LO 2 Environmental Control System”, *The Boeing Company*, Feb. 2012.
- [13] Anonymous, “Airbus A330 Flight Deck and Systems Briefing for Pilots”, *Airbus SAS*, Mar. 1999.