

# WEB BASED REAL TIME REMOTE LABORATORY WITH LABVIEW ACCESS FOR ANALOG AND DIGITAL COMMUNICATION COURSES

Ayşe YAYLA<sup>1</sup>

Aynur AKAR<sup>2</sup>

<sup>1</sup>Marmara University, Department of Electronics and Communication, 34722,  
İstanbul/TURKEY

<sup>2</sup>Marmara University, Department of Electronics and Computer Education, 34722,  
İstanbul/TURKEY

<sup>1</sup>E-mail: [acetinkaya@marmara.edu.tr](mailto:acetinkaya@marmara.edu.tr) <sup>2</sup>E-mail: [aynurakar@marmara.edu.tr](mailto:aynurakar@marmara.edu.tr)

## ABSTRACT

With the rapid developments of internet and computer technologies, accessing and operating of real time applications is becoming reality. This study presents a real time web based laboratory on analog and digital communication experiments. The experiments are designed by using LabVIEW program for Marmara University Electronics and Communication Department. Also with the help of designed web site, the student can access the virtual laboratory and perform experiments without any limitation of time and location. The student can observe the signals by changing the parameters of the experiment and evaluate the results. During the session, the teacher can watch and communicate the student who performs his/ her experiment.

**Keywords**—Virtual laboratory, LabVIEW, Analog and Digital Modulation Techniques

## 1. INTRODUCTION

Engineering education has a big importance in development of technologies. For this purpose, various methods have been developed to improve learning processes. The technological researches and developments provide new concepts in education [5]. Especially internet facilities present new approaches and methods to design virtual and real time laboratory applications for education purposes. Laboratory work is an important part of the engineering course, in which the students can make practice of what they learned in the classes, which helps them to reinforce the learning of the concepts [10].

Facilities of the laboratories in educational institutions are generally insufficient when the number of students is considered. Implementation of a laboratory to meet the requirements has a very high price.

Because of using intensively software and minimum hardware, virtual laboratories (VL) that can be controlled remotely as a real time have become alternative to the traditional laboratories. In these laboratories, students can access to the experiments without time and location limitations [6]. In the virtual laboratory, students can set up parameters of experiments from a remote

*Received Date:* 07.04.2008

*Accepted Date:* 01.07.2008

location and repeat the experiments, as they need.

LabVIEW program is one of the high level programming languages that is preferred in this study to perform VL applications. LabVIEW software provides an active and controllable interface for test, measurement, instrument control, data processing and data analysis applications [3]. By using LabVIEW program, both virtual instruments can be designed and the devices can be controlled via GPIB, RS232 or VXI interface and web based applications that users can access via internet can be performed. On the basis of LabVIEW program properties, a VL has been setup to provide an environment for both physical experiments and simulations [4].

There are many web based virtual laboratory examples in the literature and some of them can be found on the following. In [2], power electronics experiment is programmed in a remotely controlled laboratory. It is a real power electronics experiment conducted in the laboratory but remotely control and monitoring by web based tools. In [1], it presents a new web based virtual laboratory on a frequency modulation experiment for the teaching of an undergraduate course on communication principles in the National University of Singapore (NUS). It enables students to have a natural hands-on experience of using an expensive spectrum analyzer on a one-to-one basis and provides a solution for distant engineering education. In [7], a virtual laboratory that offers different aspects of instruments and circuits is described for Electrical and Electronics teaching. This laboratory is based upon the use of LabVIEW program. In [8], a web based platform for distance learning is performed. The platform is used in the course "Electrical Measurements" at Faculty of Electrical Engineering in Zagreb, Croatia. In [9], a web-based laboratory in a distance course on automatic control in the Department of

Computer Sciences and Automatic Control of the Spanish University of Distance Learning (UNED) is described.

This study describes a web based real time virtual laboratory that its purpose is to provide a tool to be used as a teaching aid in analog and digital communications course. We present a web based VL on Amplitude Modulation (AM, with carried, double side and signal side band), Pulse Code Modulation (PCM), and base band digital modulation techniques such as Amplitude Shift Keying (ASK), Frequency Shift Keying (FSK) and Phase Shift Keying (PSK) experiments are designed. For performing the above experiments in an efficient way, theoretical concepts and the procedures of real time and virtual applications related to experiments are given on the web page that is designed by using Microsoft Visual Studio 2005 and also to conduct and perform the experiments; the user only needs to install LabVIEW Run Time Engine that is placed on the user input page. In our virtual laboratory, HP 3632A DC Power supply and HP 34970A Digital Multimeter devices are controlled via GPIB interface.

In Section II, the typical user interfaces including web site of the study and LabVIEW control panels that have been installed into the web site are described. Section III describes the hardware and software system architecture and finally, conclusions are drawn in Section IV.

## 2. USER INTERFACE

### 2.1 Control Panels

In this virtual laboratory, both computer-simulated and real time applications have been performed but only the front panels of real time applications have been presented in this paper. In Fig. 1,  $Q=32$   $a=1$  PCM front panel is shown. Similarly, in Fig. 2, AM front panel and in Fig. 3, FSK front panel is shown. The front panels are called user interfaces and they have been designed as realistic as possible.

The front panels of these applications that contain two sections such as control buttons on the left and input-output waveforms of the experiments on the right are designed in a simple and intelligible structure.

In these applications, the frequency of sample impulses (PCM) and carrier frequencies (ASK, FSK, PSK, AM) is changed as virtual and the frequency of message signals is changed as real time by using control buttons. So students can change the message signals in real time via voltage controlled circuit (VCO) by controlling the connected devices (HP 3632 A DC Power Supply).

Also in the front panels, there are five types of signals such as sinusoidal, square, triangle, saw tooth and random on the message signal part. In addition to this, the front panels display message

signal, sample impulses, carrier signals as input and AM modulated signal, PCM code sequence, ASK, FSK, PSK signals as output.

The experiments can be stopped at any time by pressing stop button located at the bottom of the left side of the front panel. In order to start up the application, these graphs and control buttons must be connected in the proper form in the block diagram. These diagrams will be explained in the hardware and software section.

## 2.2. Web Site

In this study, a web site is designed to perform Analog and Digital Communication experiments and increase the efficiency of these experiments. The web site is designed both in Turkish and English languages.

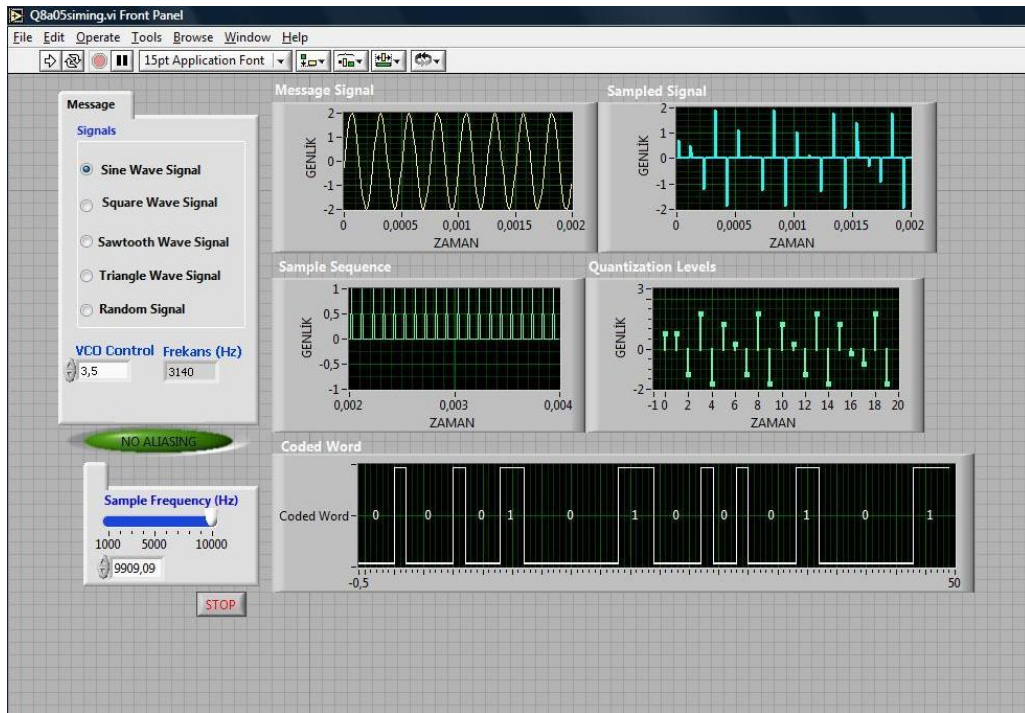

Figure1. PCM Front Panel (Q=32, a=1)

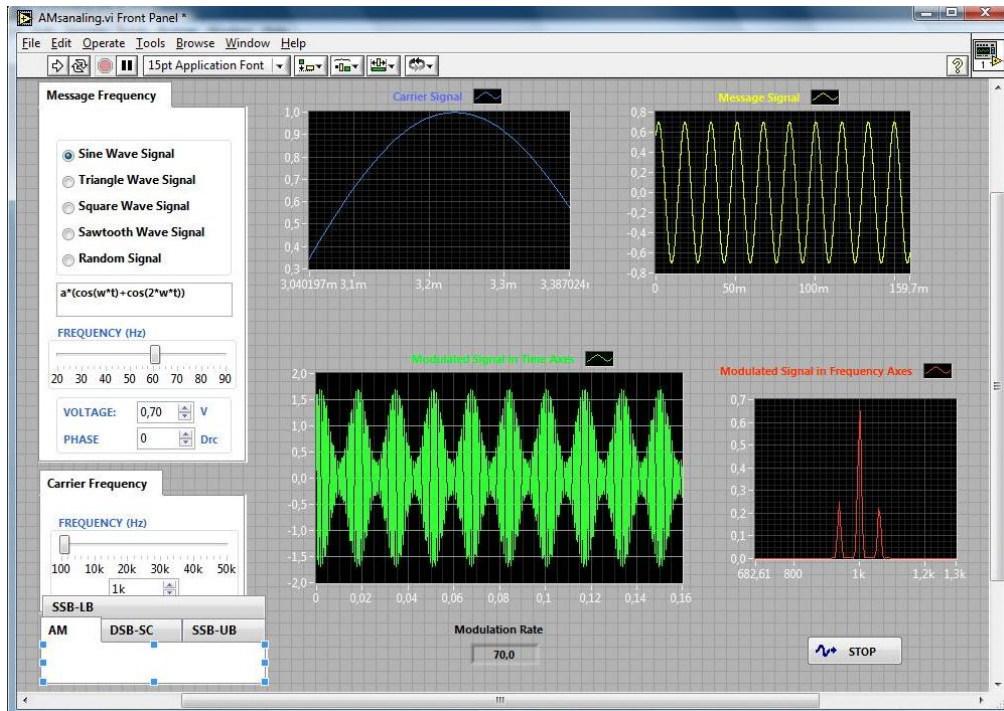

Figure2. AM Front Panel

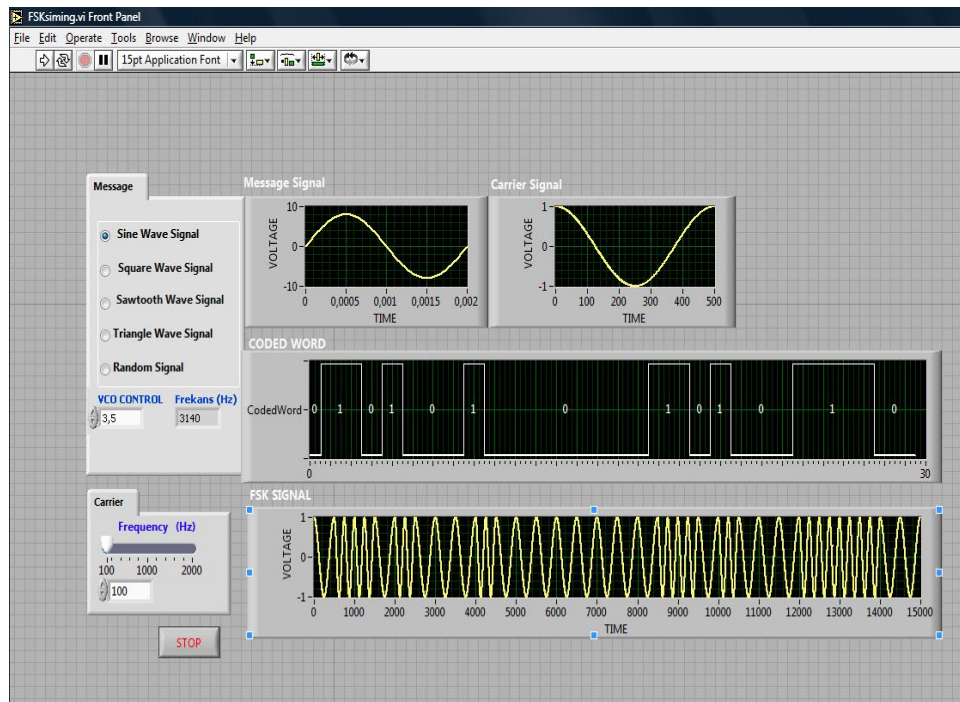

Figure3. FSK Front Panel

The web site contains the theoretical information of experiments and virtual

and real time experiment steps. The aim of these web pages is to give some

information about experiment. Any interested user can access these documents freely and install them without logging on, at the same time without interrupting the experiment. To conduct and perform the experiment, students need to have web browser and LabVIEW Run Time Engine.

The web site is designed in accordance with Microsoft Internet Explorer. In real time applications, because of controlling the devices as well, the web site is designed in order to allow only one user to access at the same time. Microsoft Visual Studio 2005 program is used for designing the web site and Microsoft Access is used for user account registration.

National Instruments has developed Dynamic Link Library (DLL) that is a function library to control the LabVIEW applications from different programming languages (Visual Basic, C++, C#) dynamically. Through this DLL, virtual instruments developed in LabVIEW program can be integrated into the .NET applications easily. Many functions and

methods presented in DLL have been used in our designed web site [11].

On the designed home page, there can be seen if there is any user in the system or not and if there is a user in the system, the experiment which the user is performing (real time or simulation) can be seen as well. In Fig. 4, the home page of web site is shown.

The necessary steps for conducting and performing the experiment are given as follows:

- Students can choose the experiment from the buttons
- Username and password for authentication is requested from the user when the user clicks to the experiment link.
- After a successful log on to the session, the user interface for controlling the instruments and performing the experiment will appear.
- Students can now change the experiment parameters such as the control voltage of VCO circuit to get message frequency, sampling frequency and carrier frequency and obtain the results.

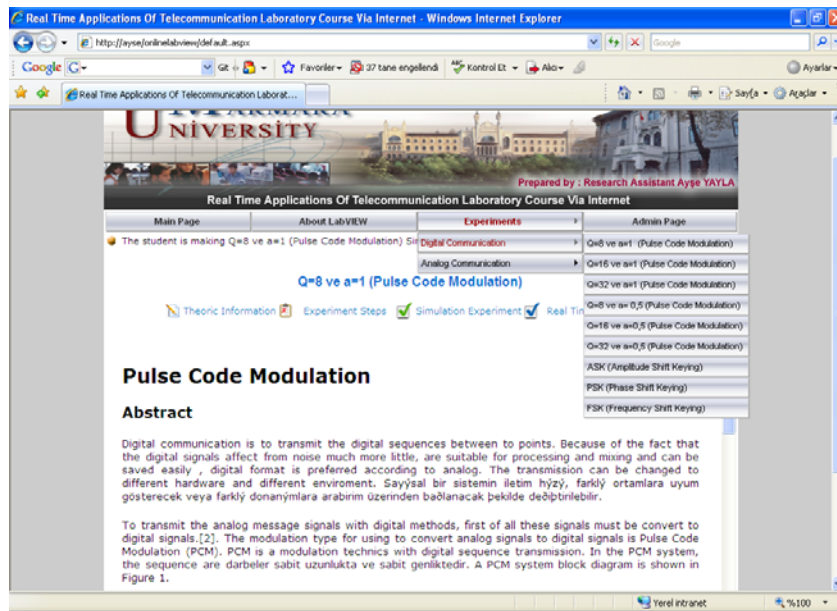
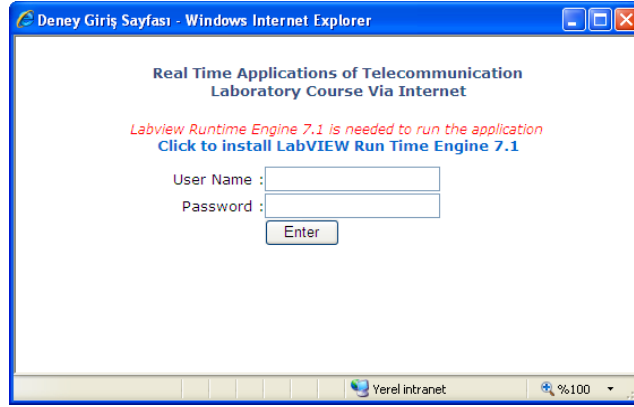

Figure4. Home Page



**Figure5.** Application Input Page

- While the student is performing the experiment, teacher may only observe the experiment simultaneously. During the session, if the student changes the parameters of the experiment, the teacher can only watch these changes and also student and teacher can communicate with each other via the chat platform developed in the web application.
- Students are allocated with 15 minutes and the session can be terminated by the user any time or after a default time limit of 15 minutes. When the student finishes the experiment, the message “The student finished the experiment” is shown on the teacher web page.

Because of the fact that, students are able to perform the device control in the experiment as well, the web site allows to access only one student at the time.

In order to add or erase experiments, update the current experiments and disable / enable the system, an administrator page is designed in web site as shown in Figure 6. When the system is deactivated by the system manager (generally teacher), nobody can access the experiments. If somebody wants to access the experiments at this time, “Because of deactivating the system, you can not access the experiments” message is shown. When the system is deactivated, the student can only access the other pages such as LabVIEW information, experiment menus.

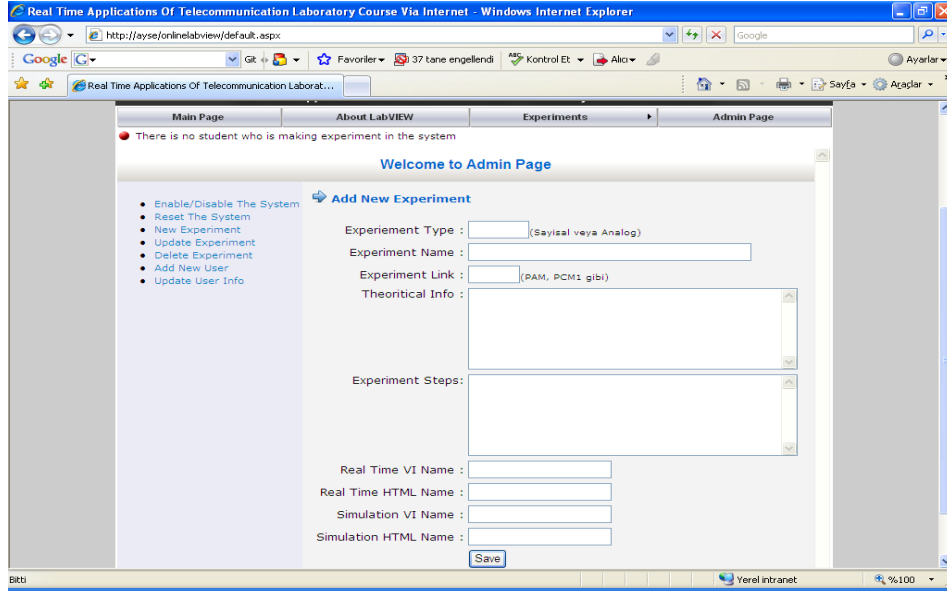

Figure6. Administrator Page

### 3. SYSTEM ARCHITECTURE

#### 3.1 Hardware System

The hardware system and its components of the real time Analog and Digital Communication experiments are shown in Fig. 7.

In this hardware structure, HP3632A DC power supply and HP 34970A digital multimeter devices have GPIB card and are connected to server PC through GPIB card and cables. LabVIEW is adopted to implement local instrument control. On the basis of the GPIB address assigned to the instrument, the commands are transferred through the GPIB card and cable to the corresponding instrument which

implements the commands and executes the actions. Laboratory PC which includes GPIB and Ethernet interfaces is called as a server PC and communicate as a full duplex form with digital multimeter and DC power supply.

By using Voltage Controlled Oscillator (VCO) as shown in Fig. 9, message signal has been obtained for experiments. The input signal of VCO is controlled by the HP3632A DC power supply with GPIB and the output signal of VCO circuit is measured with HP 34970A digital multimeter and then sent back to the Laboratory PC through the GPIB. This measured signal is applied to the system as a message frequency.

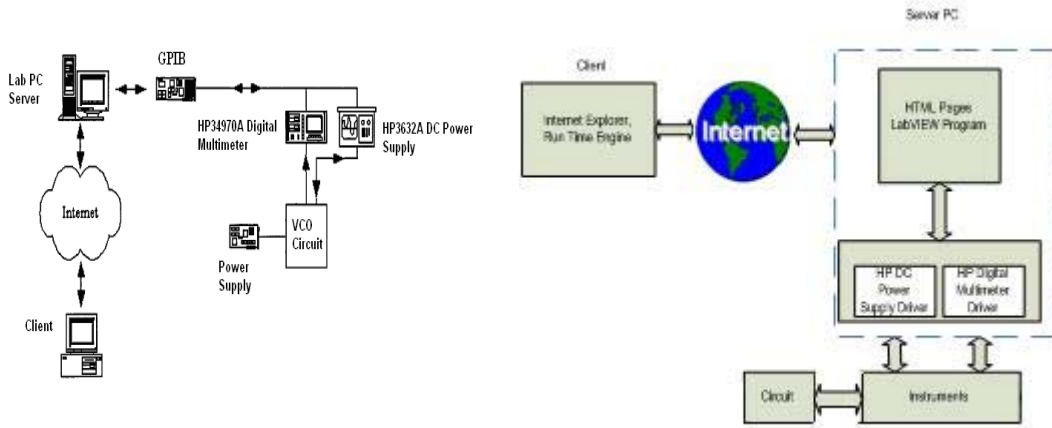

**Figure7.** Hardware Structure of Application **Figure8.** Software Structure of Application

VCO circuit converts the voltage between 3,5 to 5,5V to the frequency between 1,6 to 11 kHz.

With the designed VCO circuit, the message signal of real time PCM

experiment and carrier signals of ASK, PSK and FSK experiments are get.

In Fig. 10, the set of the instrument located in a standard laboratory is shown

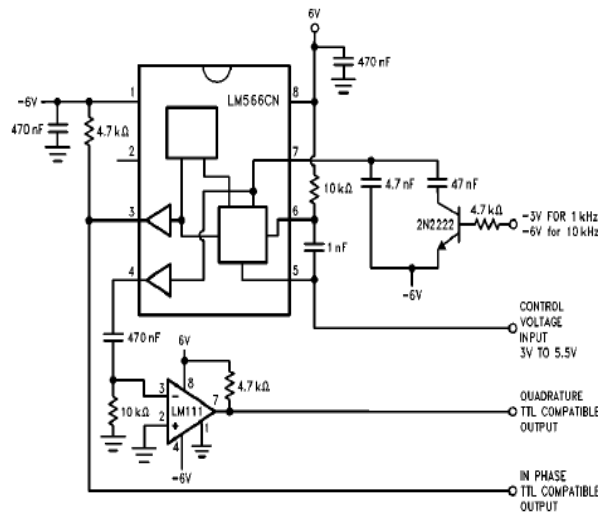

**Figure9.** VCO circuit



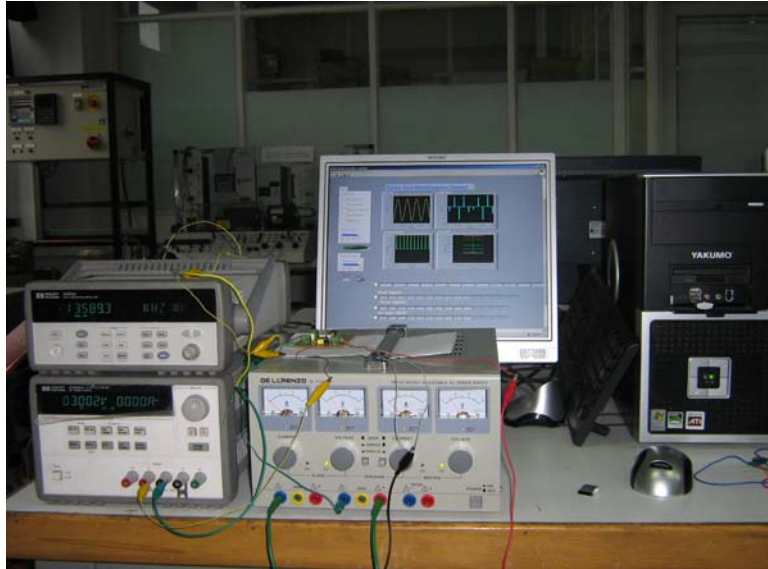

Figure10. Laboratory Appearance of Application

### 3.2 Block Diagram

The block diagrams are the main part of the experiments. Connections between the VI's, analog I/O are implemented under LabVIEW using the G

programming language. Also programs are verified by using Formula node in the block diagram. In Figure 11, as an example, the block diagram of PCM experiment is shown.

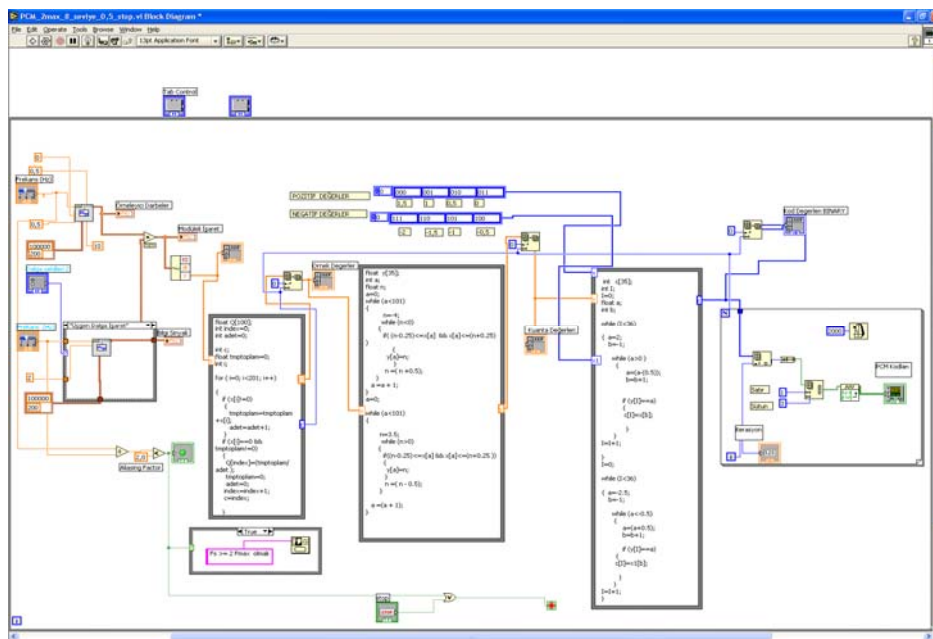

Figure11. PCM Block Diagram Structure ( Q=32, a=1)

A block diagram of the PCM experiment contains four sections. In the

first section, by using signal generation VI's, the message and sampling frequency are generated. Then a program

is written in Formula Node to select sample values. In the third section, in Formula node, a program is developed to allocate levels to the infinite range of amplitude of sample values of the analog signal using uniform quantization operator. This program is carried out by using quantization parameters (quantization step size  $a=1$  and  $a=0,5$ , the quantization levels  $Q=8, 16, 32$ ).

In the last section, encoding operation is performed by developing a program in Formula Node. In this step, each quantization level is expressed in a code. According to number of quantization levels, code word length ( $n$ ) is selected 3, 4, 5 bits.

$n$  bits (0,1) binary code words are converted to Binary- Non-Return to Zero (B-NRZ) pulse sequences to transmit.

For the other experiments, similar block diagrams are developed

According to digital source data (0 and 1), in ASK experiment the amplitude of carrier signal, in FSK experiment the frequency of carrier signal and in PSK experiment the phase ( $0, \pi$ ) of carrier signal is changed.

Each of three experiments uses PCM experiment digital signals as digital source data. This means that, source is the digital output of analog signal. Consequently, by changing the analog message, the student can get the digital source data that is converted analog to digital. The modulated signals are received by developing structures for each of them.

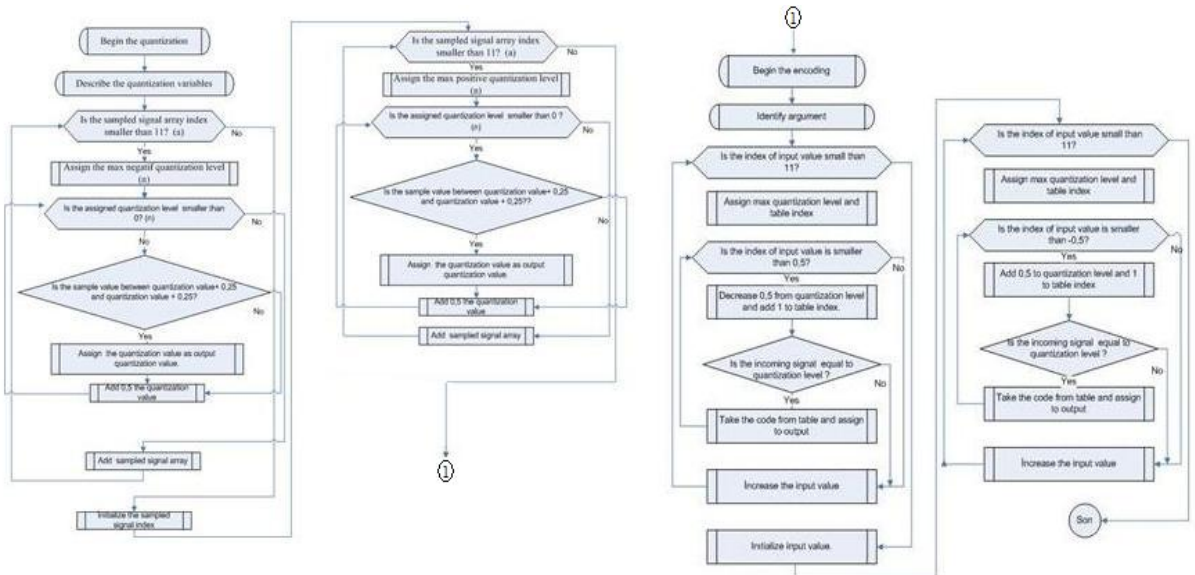

Figure12. PCM Block Diagram Algorithm (Q=32, a=1)

#### 4. CONCLUSION

In this study, for supporting laboratory applications of students, a general methodology has been presented to create real time and virtual experiments of Analog and Digital Communication courses. And also this study supports effective and complete learning and

provides a solution for distant technical engineering education. The aim of these experiments is to study the frequency spectra of AM, DSB, SSB modulated signals and time spectra of PCM, ASK, FSK, PSK signal forms according to input parameters. These experiments are designed based on theoretical knowledge.

Various experiments corresponding to modulation techniques have been designed under LabVIEW program to real time and virtual applications. Hereafter, it is planned on to develop the demodulation applications of these experiments. This methodology can also be extended to other communication system techniques. Users can access the virtual laboratory in Marmara University campus.

#### ACKNOWLEDGEMENT

This work is supported by Marmara University Technological Research Projects Commission under Grant FEN-YLS -290107-0034

- [3] Higa, M.L., Tawy, D.M., Lord, S.M., "An Introduction to Labview Exercise for An Electronics Class", *32nd ASEE/IEEE Frontiers in Education Conference*, 2002
- [4] LabVIEW Manual , National Instruments, 2005
- [5] Basher, H. A., Isa, S. A., " On – campus an Online Virtual Laboratory Experiments with LabVIEW", *Southeast Conference*, pp. 325-330 , 2006
- [8] Jurèviã, M., Malariã, R., Šala, A."Web Based Platform for Distance Training On Electrical Measurements Course", *Measurement Science Review* pp.36-39, 2006
- [9] Dormido, S., Vargas, H., Sánchez, J., Duro, N., Dormido, R., Canto, S.D., Esquembre, F." Using Web-based laboratories for Control Engineering Education", *International Conference on Engineering Education*, 2007

#### REFERENCES

- [1] Ko, C.C., Chen, B.M., Han, J., Hu, S. Ramakrishnan, V., Cheng , C.D., Zhuang, Y., Chen, J., "A Web-Based Virtual Laboratory on a Frequency Modulation Experiment ", *IEEE Transactions on Systems Man. and Cybernetics*, pp 295-303, 2001
- [2] Cheng, K.W.E., Chan, C.L., Cheung, N.C., Sutanto, D., "Virtual Laboratory Development for Teaching Power Electronics", *Institute of Electrical and Electronics Engineers*, pp. 461-466, 2002
- [6] Basher, H. A., Isa, S. A., Henini, M. A., "Virtual Laboratory for Electrical Circuit Course", *IEEE Southeast on 2004 Conference Proceedings*, pp. 330-334, 2004
- [7] Xiaoyan, C., Xiaodong, Z., Xi, C. "A Virtual Laboratory for Electrical and Electronics Teaching", *IEEE International Symposium on Microwave, Antenna, Propagation and EMC Technologies for Wireless Communications Proceedings*, pp. 491-495, 2005
- [10] Salzmänn, Ch., Gillet,, D., Huguenin, P. "Introduction to Real-time Control using LabVIEW with an Application to Distance Learning", *International Journal of Engineering Education* ,pp. 255-272, 2000
- [11] National Instruments. "Distance-Learning Remote Laboratories using LabVIEW." Available: [http://one.ni.com/devzone/conceptd.nsf/webmain/7BD0B01FCF3CF61A86256B510059F0FB/\\$File/WP223.pdf](http://one.ni.com/devzone/conceptd.nsf/webmain/7BD0B01FCF3CF61A86256B510059F0FB/$File/WP223.pdf) (2002)